



System monitoring | Vacuum switches

Vacuum switch – electromechanical

Vacuum switch – electromechanical

With NO/NC function for DC- and AC-connection



Product notes

- > An electrical signal is triggered when set vacuum value is reached
- > Switching point set via setscrew
- > Hysteresis is fixed
- > Standard vacuum connection via galvanized steel G1/4 screw-in port
- > Long service life due to high quality, robust design
- > Can be mounted in any position

Ordering notes

- > If desired the switching point can be preset

Technical data

Item no.	20.011
Adjustable range [mbar (psi)]	20 - 800 (0.3 - 11.6)
Hysteresis	6 % switch point
Switching capacity DC up to 28 V [A]	max. 2
Switching capacity AC up to 250 V [A]	max. 2
Max. switching frequency [Hz]	200
Protection class	IP65
Suitable media	Filtered, oiled or unoled air or neutral gases
Operating temperature [°C (°F)]	-25 - 85 (-13 - 185)
Weight [g]	120

Dimensions

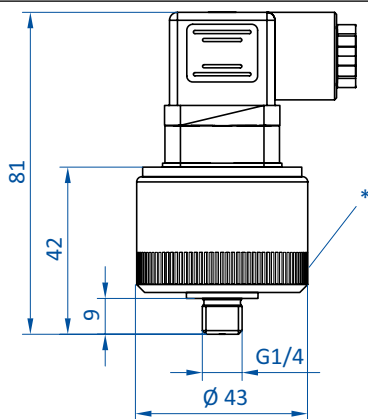

* = Knurled screw

Electrical connection / changeover contact

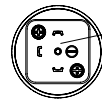

Setting screw
M3 DIN 914

1. Completely screw in with hex-wrench
2. Apply switching vacuum
3. Ease screw until contact toggles

Wiring

